

Spencer®

Central Vacuum Systems

Industrial • Institutional • Commercial

The whole purpose of a central vacuum system is to make problems go away, including those you didn't know there were solutions for.

Forget what “everybody knows” about vacuum cleaning.

What “everybody knows” is often based on an upright or canister vacuum cleaner back home. But the vacuum cleaner built for a two hour work week in the home is out of its element in industry. To go after industrial-strength cleaning challenges, you need a solution that's bigger than the problem.

Forget about scattering vacuum cleaners around a plant to deal with litter, production scrap and every other miscellaneous mess. After all, you don't pass out flashlights to everyone who needs a light.

Start thinking in terms of a *vacuum utility* you can use everywhere just like electricity.

Just as you have a plant-wide electrical system that you plug into for lighting and other uses, you should extend a vacuum network throughout the production, warehouse, laboratory and office areas. Then you'll have convenient “vacuum taps” right where they're needed. Once your vacuum utility is in place, you'll find more and more uses for it.

The whole purpose of a central vacuum system is to make problems go away, including those you didn't know there were solutions for. Spencer systems can be designed for bulk material conveying, recyclable material collection, toxic waste removal, liquid pickup and disposal, vacuum hold-down or pickup in manufacturing operations, machine side dust and fume collection—all in addition to heavy-duty cleaning operations.

Spencer systems are custom-designed to clean up anything from gravel to gum drops, bagels to brick chips. Just tell us the problem.

Too many times, people anticipate a negative answer when they ask, “Say, I don't suppose you could vacuum up ...”. Our best advice is, don't assume anything. Talk to our experts!

Spencer specializes in creating custom solutions to deal with nearly anything—steel balls, shredded vegetables, kerosene, hair, graphite, cotton swabs, talcum powder, pet food, coins, welding fumes, magnesium powder, phenolic dust, carbon black, battery acid, shot blast grit, candy bars, flour dust, torpedo fuel ... you get the point. The system we create for you will suit your specific requirements, whatever they may be.



When you buy a Spencer central vacuum system, it will run for years and do what it was designed to do every day.

Air handling has been our specialty since 1892.

Since Ira Spencer invented his first air handling systems in the 1890's, we have specialized exclusively in this field. The first Spencer Turbine Vacuum Cleaner was introduced in 1905. It has since retired, but there are many Spencer central vacuum systems still running after decades of daily service.

The "sleep good at night" factor.

Spencer systems last because they are built to last. They are engineered with plenty of reserve performance so that you will always be satisfied with your choice. When you buy a Spencer central vacuum system, it will run for years and do what it is supposed to do every day. We call that the "sleep good at night" factor because you've made a decision you'll never lose sleep over.

All the support you could ever need.

Spencer has direct sales offices and manufacturers representatives across North America, and independent representatives in many countries. Altogether, we have the industry's largest representative organization.

Backed by our staff of professional engineers—also the industry's largest—our representatives can evaluate your application and recommend an effective system based on your cleaning volume and characteristics, facility layout and future needs.

After the sale, your Spencer representative will be there to help with the installation and startup of your system, making sure components are assembled and adjusted correctly. You can count on Spencer to stand by you.



A system approach to the task of making problems go away.

All the work of a vacuum system is performed by pressure, not suction. In a cleaning application, room air rushing into a cleaning tool carries nearby solids or liquids along with it. There must be an adequate pressure differential at the tool and throughout the hose and tubing system to overcome system resistance and sustain a conveying velocity.

To create a high-velocity inrush of air, a Spencer central vacuum system has a powerful vacuum producer, often a multistage unit that builds and holds a high negative pressure, even with several operators on-line at once.

Once material is in motion inside a hose and tubing network, the airflow carries it back toward the vacuum producer. Various types of separators are positioned between the pickup point and vacuum source to intercept and collect the conveyed materials, whether wet or dry, usable or disposable.

The complete system consists of a pickup point, conveying system, separating stage and vacuum producer.

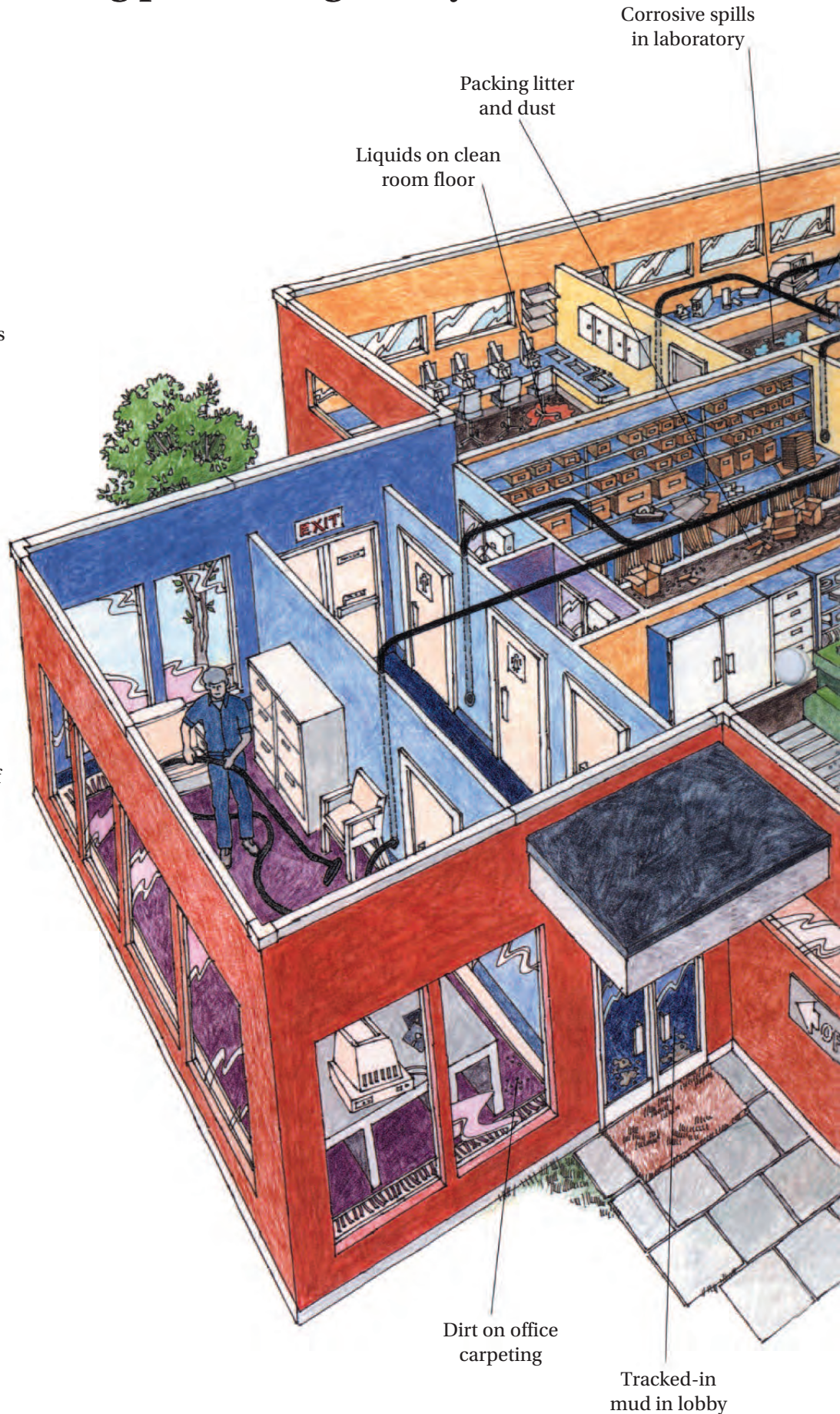

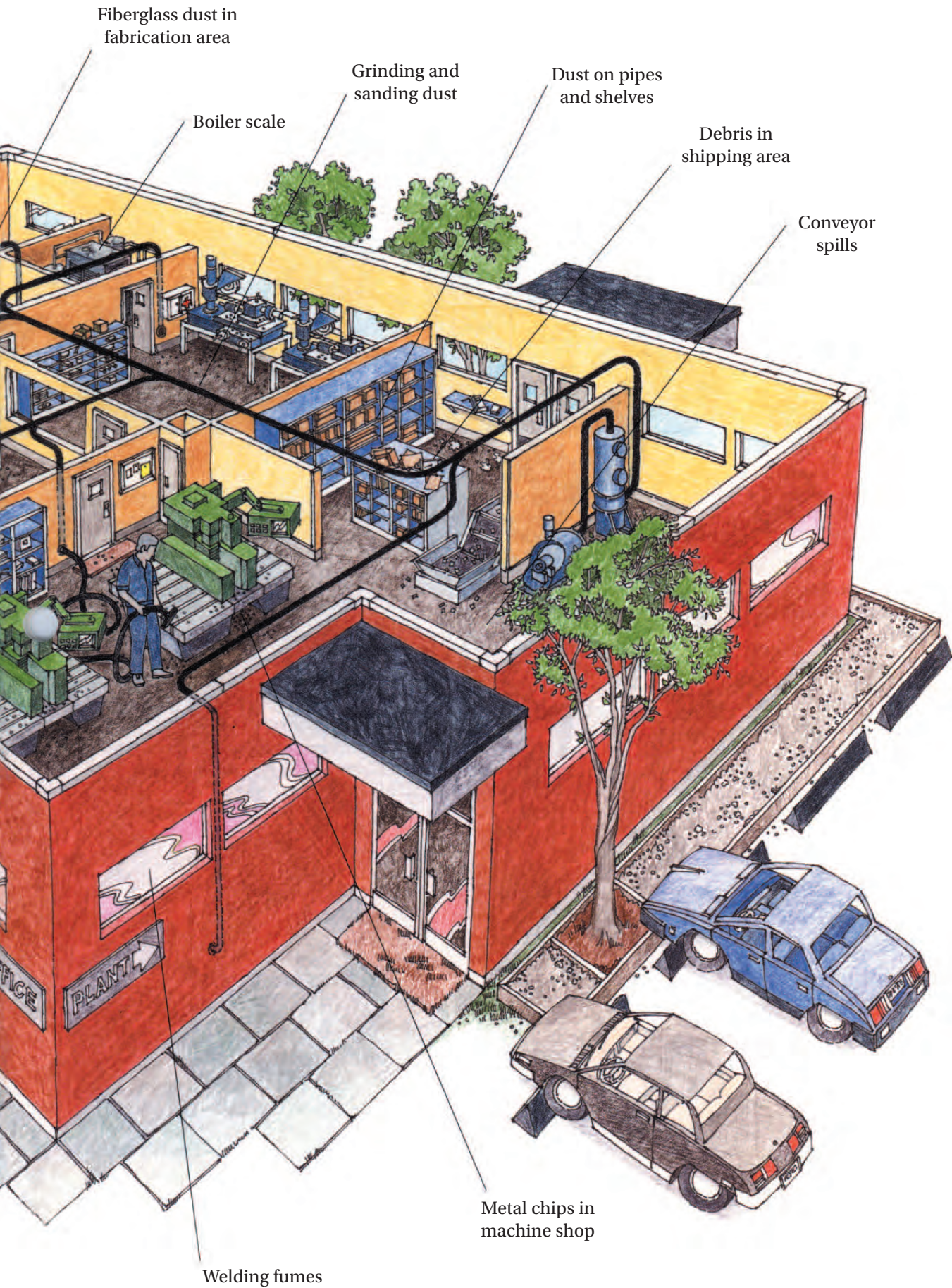

Spencer Vacuum Producers



Standard Overhung Multistage Centrifugal

Our most popular design, with impellers mounted on the motor shaft. Simple two-bearing design reduces maintenance.

Vacuum: to 8" Hg
Volume: to 5,000 SCFM
Power: to 150 HP

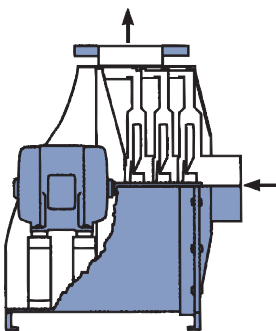

Four Bearing Overhung Multistage Centrifugal

Impellers are mounted on the machine shaft; rotating elements are supported by a rigid bearing bracket. Standard shaft motor is furnished, or use your own.

Vacuum: to 10" Hg
Volume: to 8,000 SCFM
Power: to 250 HP

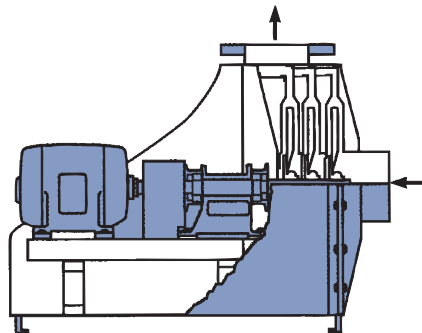

Four Bearing Outboard Multistage Centrifugal

For higher vacuum applications. Impellers are mounted between supporting bearings. Outboard bearings are a matched set, one for radial loads, the other for thrust loads. Inboard bearing absorbs a share of the radial load and supports vacuum producer shaft at the discharge end. Motor is furnished, or use your own.

Vacuum: to 14" Hg
Volume: to 15,000 SCFM
Power: to 1250 HP

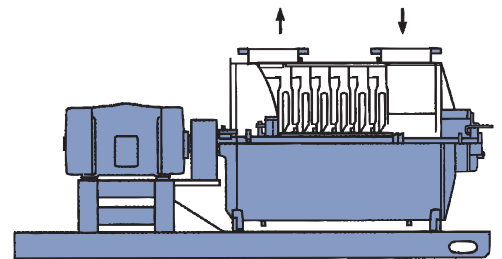

Spencer Vacuum Producers



Power Mizer® High Efficiency Multistage Centrifugal

Made with rugged cast iron and cast aluminum components for extra-heavy-duty service. Unique shaped impellers and other advancements produce a peak adiabatic efficiency about 80%.

Vacuum: to 19.5"
Volume: to 16,000 SCFM
Power: to 1500 HP

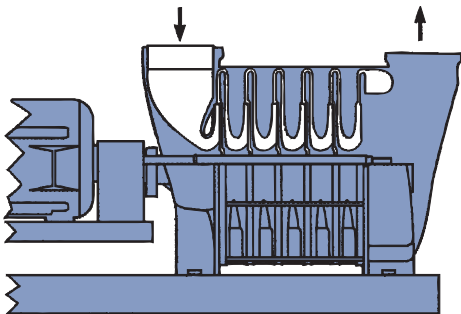

24" Belt Drive Multistage Centrifugal

Standard four bearing overhung design in a belt drive arrangement. Output can be varied by changing pulley sizes. Standard shaft motor is furnished, or use your own. Diesel, propane or gasoline engine driver may be substituted for electric motor.

Vacuum: to 10" Hg
Volume: to 1,800 SCFM
Power: to 50 HP

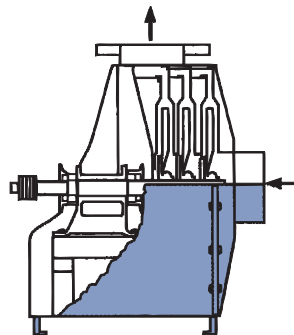

Power Mizer vacuum producer with pulse-type separator providing a continuous duty, high velocity dust collection system at a printed circuit board manufacturer.



Spencer central vacuum system serving a pharmaceutical R&D facility and production cleanroom includes standard overhung vacuum producers with acoustical wraps; an extensive, large-diameter vacuum tubing network; and Spencer separators designed for high-velocity dust collection.

Spencer Vacuum Producers

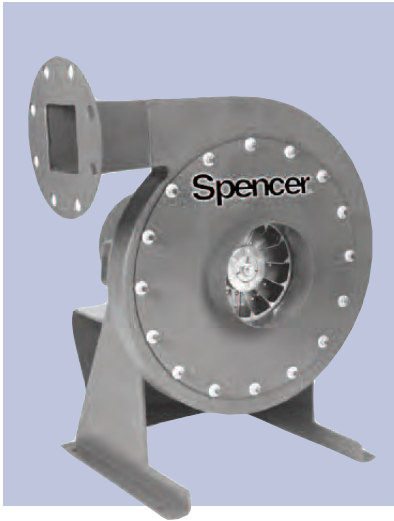

Single Stage Centrifugal

Medium-duty scroll design machine for low volume and vacuum requirements.

Vacuum: to 3.5" Hg
Volume: to 6,000 SCFM
Power: to 60 HP

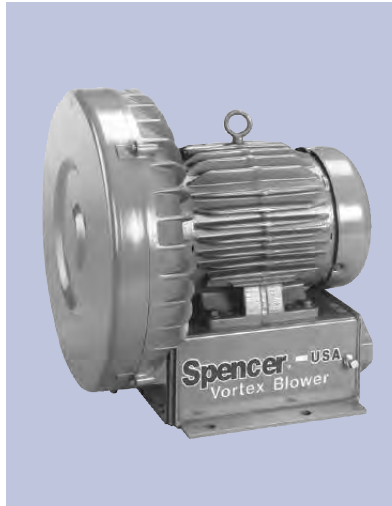
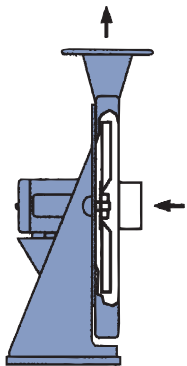

Vortex® Regenerative

Compact single stage regenerative units suitable for limited-space installations.

Vacuum: to 8" Hg
Volume: to 600 SCFM
Power: to 15 HP

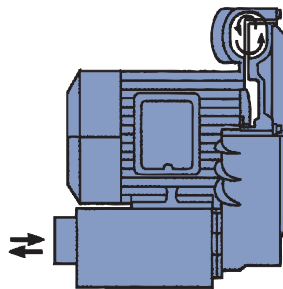

Spencer Vacuum Systems



Large Spencer system has 27 standard overhung vacuum producers arranged in tiers (right), connected to a bank of five centrifugal separators and six tubular bag separators, to serve a cleanroom facility for automated computer disk production.

Special Designs

We can honestly say that Spencer makes everything you need in vacuum producers, because we will modify any design to suit your application. These are some examples of the specials already produced:

- Alternative drivers such as gasoline, propane or diesel engines.
- Alternative drive arrangements such as belt or gear drive, which can be fitted to most vacuum producer types.
- Multiple vacuum producers, packaged on a common base.
- Special materials such as aluminum, Hastelloy® and stainless steel, and special interior or exterior coatings for vacuum producers.



"Triplex" vacuum system at a Connecticut hospital evacuates laser surgery smoke from operating rooms using three Spencer standard overhung vacuum producers, galvanized wet separator, secondary HEPA filter, controls and vacuum tubing network.

Spencer Separators



Standard Centrifugal

Centrifugal action removes granules and large particles. Usually used as a primary separator prior to a filtration separator (bag or cartridge).



Hopper Bottom with Legs

Removable Dirt Can

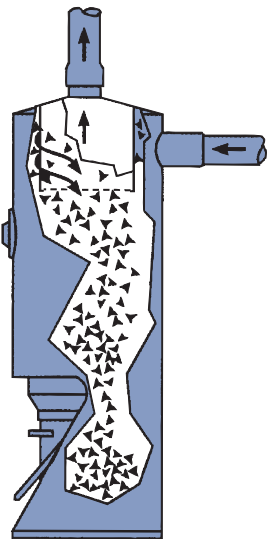

Hopper Bottom with I-Beam Mounting Pads

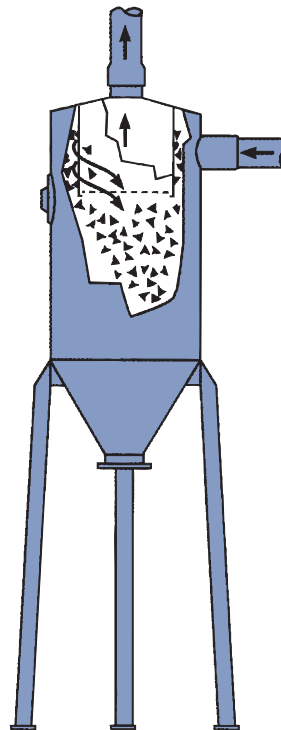
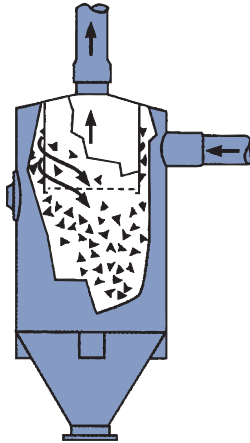

High-Efficiency Centrifugal (Cyclone)

Elongated cone creates a cyclonic centrifugal action for higher separation efficiency. Requires continuous discharge from the separator or addition of a surge hopper for material storage. Often used for pneumatic conveying.

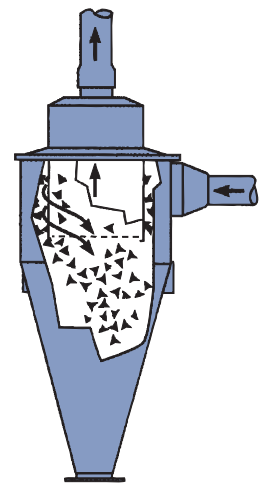

Spencer Separators



Top Hat®

Small centrifugal drum-top unit typically connected to a cleaning hose; used as a pre-separator to segregate materials for reuse or disposal before they can mix with the main dirt stream. Two sizes for 30 and 55 gallon drums; easily moved from drum to drum.

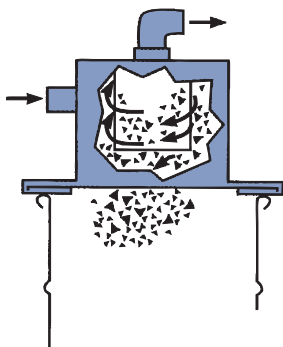

Wet Centrifugal

Stationary central unit for separating liquids from the air stream of a wet vacuum system. Available in galvanized steel, stainless steel, aluminum and other corrosion-resistant

metals. Ball float shut-off prevents overflow. Range of capacities from 43 to 307 gallons. Automatic emptying devices are available.

Flat Bottom

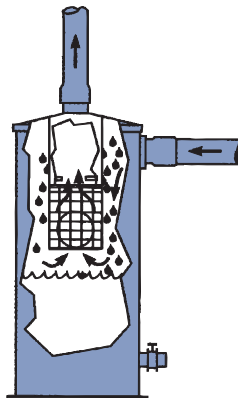

Short-Cone Bottom with Legs

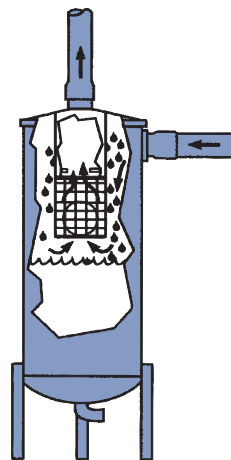

Portable Wet Pickup

Small mobile unit attaches to a cleaning hose to isolate and collect liquids before they can contaminate the dirt stream of a dry vacuum system. Typical uses are drying of just-washed floors and removing spills. Aluminum construction; capacities from 8 to 24 gallons.

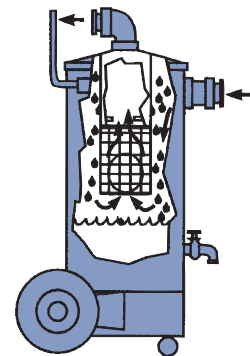

Spencer Separators



Tubular Bag

May be used individually or in series after centrifugal separator to trap over 99% of all remaining solids. Two-stage separation with centrifugal separator is highly efficient even with

difficult materials such as pigments and powders. Many types of filter media available; bag cleaning may be manual or automatic after shutdown.

Hopper Bottom with Legs

Removable Dirt Can

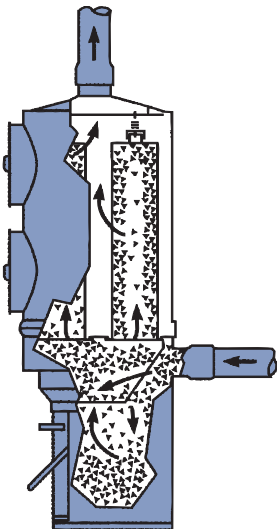

Hopper Bottom with I-Beam Mounting Pads

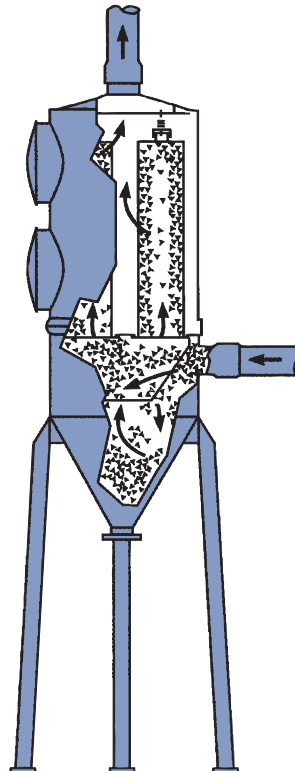
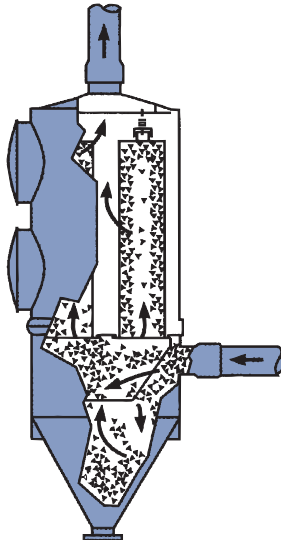

Two Spencer four-bearing overhung vacuum producers provide suction to a centrifugal and tubular bag separator. These support a system drawing dust and chips from a large machining operation of composite automotive components.



Spencer central vacuum system in Springfield, MA, supports a regional effort to recycle solid waste, generate electricity and maintain excellent air quality.

Spencer Separators

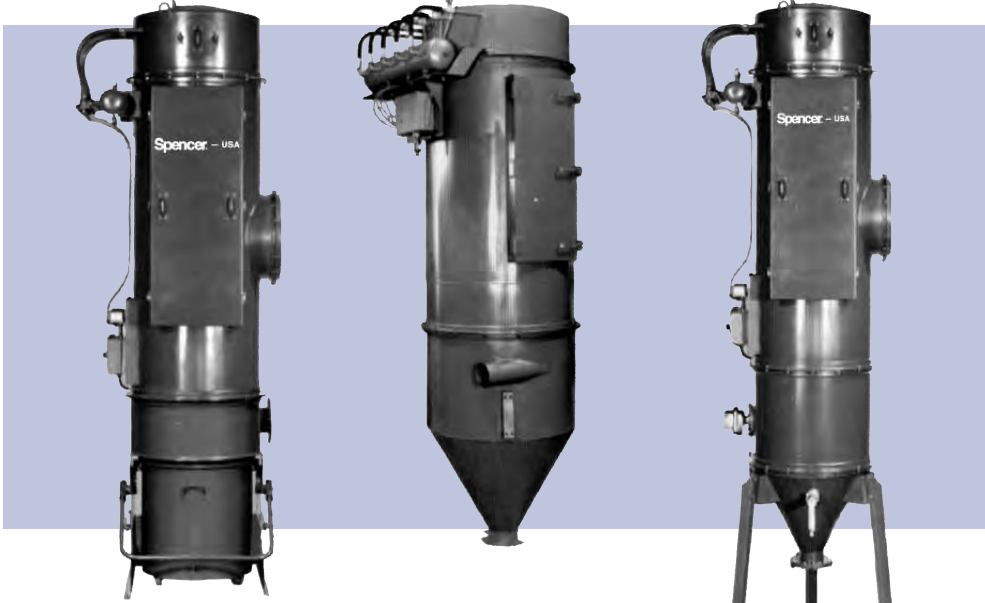

Jet-Clean®

Filter bag separator that has been adapted for continuous operation. A built-in timer periodically activates air jets to clean the filter bags while the system is running.

Cleaning is sequential, allowing some bags to filter while others are being cleaned.



Cartridge

Similar to Jet-Clean separator, with filter cartridges instead of filter bags. The cartridges are fabricated of various pleated materials. Periodic, sequential air jet activation cleans the cartridges, allowing continuous operation.

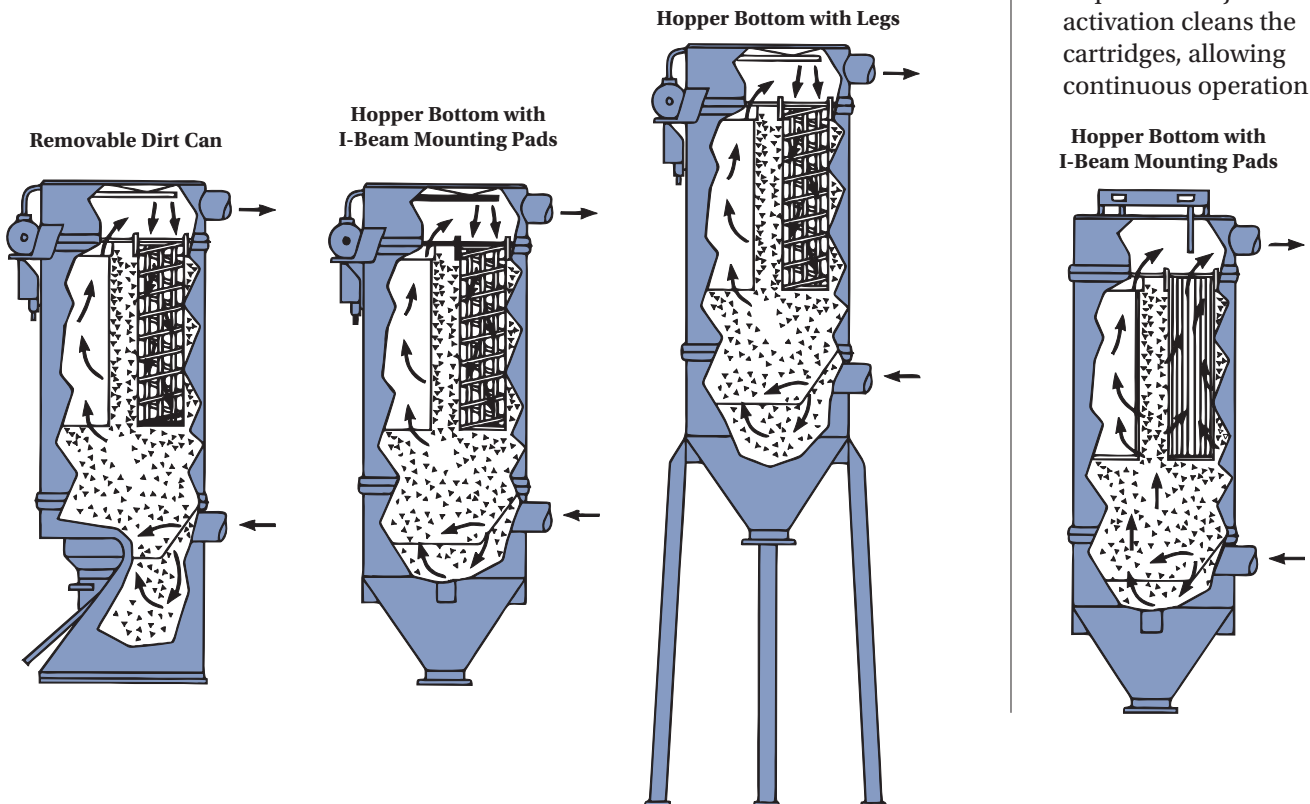

Spencer Separators



Immersion

Special design for handling sensitive materials such as flammables. All material passes through a water filtration chamber. Separator contents can be emptied by gravity or pressure. Galvanized steel, stainless steel or aluminum construction.

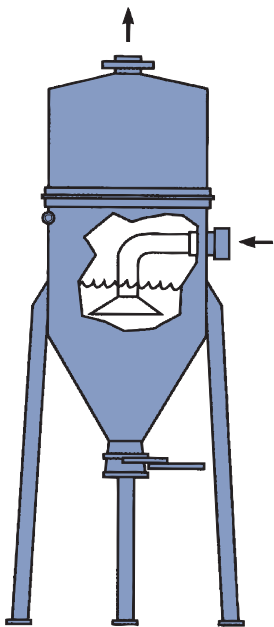

Special Designs

Spencer separators can be specially configured to offer unique capabilities, discharge convenience or other features as desired.

One optional design is the storage compartment separator with oversized collection bin, which can accumulate large amounts of material. This design is available with both centrifugal and tubular bag separators.

Another variation, similar to a Top Hat separator in appearance, has been specially designed to collect glass fiber strands and similar hard-to-handle scrap materials.

A third unique design features an extremely wide-mouth separator, fitted with an oversize trapdoor to discharge hard-to-empty materials such as found in the textile and paper industries.

And a fourth special type, the Bag In/Bag Out Separator, has unique abilities to collect toxic materials such as arsenic powder. This separator is designed to help companies comply with OSHA regulations by limiting personnel exposure to hazardous substances.



Custom 42" Jet-Clean cartridge separator with modified hopper bottom, explosion relief port, manual debridger and solenoid valve assembly, handling cereal spills for a breakfast food manufacturer.



Spencer Separators

Separator Capacities

Maximum Air Volume			Standard Filter Bag Areas in Tubular Bag and Jet-Clean Separators, sq. ft.		
Separator Dia., in.	Centrifugal Sep., SCFM	Tubular Bag Sep., SCFM*	Separator Dia., in.	Tubular Bag	Jet-Clean
20	—	185	20	31	—
24	320	320	24	53	50 or 66
30	640	610	30	102	88 or 117
36	1200	1075	36	179	113 or 150
42	1600	1510	42	252	175 or 230
50	2400	2050	50	341	238 or 318
60	4000	3000	60	495	351 or 468
72	6400	4100	72	682	—

*Based on 6:1 ratio, air volume to filter bag area.

Maximum Usable Material Storage Volume for Centrifugal, Tubular Bag and Jet-Clean Separators						
Separator Dia., in.	Hopper Bottom, cu. ft.			Removable Dirt Can, cu. ft.		
	Centrifugal	Tubular Bag	Jet-Clean	Centrifugal	Tubular Bag	Jet-Clean
20	—	2	—	2.25	2.25	—
24	16	4	2	3	3	3
30	24	7.5	6	7.5	7.5	3 or 7.5
36	34	12	8.5	7.5	7.5	3 or 7.5
42	43	16	12	7.5	7.5	3 or 7.5
50	71	22.6	15	7.5	7.5	3 or 7.5
60	97	35	26	7.5	7.5	3 or 7.5
72	130	64	—	—	7.5	—

Separator Selection by Type and Volume of Material

Material Description	Volume of Material		
	Light (e.g., clean room, lab)	Average (e.g., shipping or assembly area)	Heavy (e.g., foundry, manuf. plant)
Very fine (100 mesh)	Tubular bag (3:1 air volume to bag area ratio)	Tubular bag (3:1 air volume to bag area ratio)	Centrifugal, Jet-Clean and tubular bag (3:1 ratio)
Fine (100 mesh to 1/8")	Centrifugal	Centrifugal and tubular bag (6:1 ratio)	Centrifugal and tubular bag (6:1 ratio)
Granular (1/8" to 1/2")	Centrifugal	Centrifugal	Centrifugal and tubular bag (6:1 ratio)
Lumpy (lumps over 1/2")	Centrifugal	Centrifugal	Centrifugal
Irregular (e.g., fibrous, stringy)	Separator selection dependent on specific material		
Liquids	Wet centrifugal or portable wet pickup separator		

Spencer Options and Accessories

Dozens of special-purpose components and accessories are offered by Spencer for specific functions or operating and control convenience. All items may be ordered for installation at the factory; some can be customer-installed.

Hose and Tools

Vacuum Cleaning Attachments and Accessories Catalog, Bulletin 241, contains Spencer's comprehensive line of hoses, cleaning wands, hand and floor tools, inlet valves, connectors, adapters and accessories for every application from general floor cleaning to specialized bulk material handling.

Replaceable Intake Section

Replaceable section of abrasion-resistant steel, with or without special coatings, for handling abrasive materials.

Rotary Valve - Variety of rotary valves for continuous discharge of free-flowing, non-abrasive materials during operation.

8" Discharge Valve - Hand-operated valve to discharge hopper contents after system shutdown.



12" Slide Valve - Hand-operated slide to empty hopper after shutdown.



Swing Valve - Lever-operated valve for partial emptying of hopper contents after shutdown; various diameters to 14".



Broken Bag Detector

Electronic device to alert operator of possible hazardous material release to the environment.

Motor-Operated Bag Shaker

Motorized mechanism for automatic bag shaking after shutdown; also available with motor starter and timer.

Explosion Relief Port

Sized according to NFPA guidelines to relieve vessel pressure in case of explosion to avoid equipment damage or personal injury.

Special Material

Standard construction for dry separators is carbon steel with epoxy primer inside and outside, painted with urethane semigloss exterior finish. Also available: hot-dipped galvanized steel, Corten steel, abrasion-resistant steel, aluminum, stainless steel.



Counterweighted Valve - Swing-type valve allows high density materials (35 lbs/cu. ft. or more) to drop from separator upon shutdown.

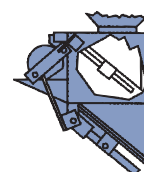

Dump Valve - Double-action, motor-operated valve for continuous discharge of separator contents (materials less than 35 lbs/cu. ft.) during system operation.



Double-Dribble Valve - Double-chamber, double-valved system for continuous hopper discharge during operation; may be used for abrasive materials. Density must be 35 lbs/cu. ft. or more.

Spencer Options and Accessories

Canvas Neck and Barrel Cover

Allow discharge of collected material directly into customer-supplied drum after shutdown, lessening dust contamination.

Custom Electrical Control Panels

Spencer offers complete in-house capabilities for control system design and implementation, including sophisticated PLC or microprocessor-controlled systems with operator interfaces. Any control panel may be furnished with UL Listed components upon request.

Other possibilities include overload protection, vibration and discharge air temperature monitoring, bearing temperature protection, data acquisition instrumentation and remote process controls.

Tubing and Fittings

Tubing, Fittings, and System Components Catalog, Bulletin 600, covers all vacuum network components from metal tubing, elbows, branches, couplings, reducers, adapters and shrink sleeves to air gates and check valves - everything you need for installation convenience.

Differential Vacuum Gauge

Measures vacuum differential across filters to indicate cleaning need. May be connected to the control panel to activate a warning device.

Grounding System

For grounding separator and filter bags. A network of copper wires in filter bags is grounded to separator, which is connected to grounding lug.

Dirt Can Liner

Plastic bag and required vacuum equalizing line for use with dirt can separators to make handling of collected material cleaner and easier.

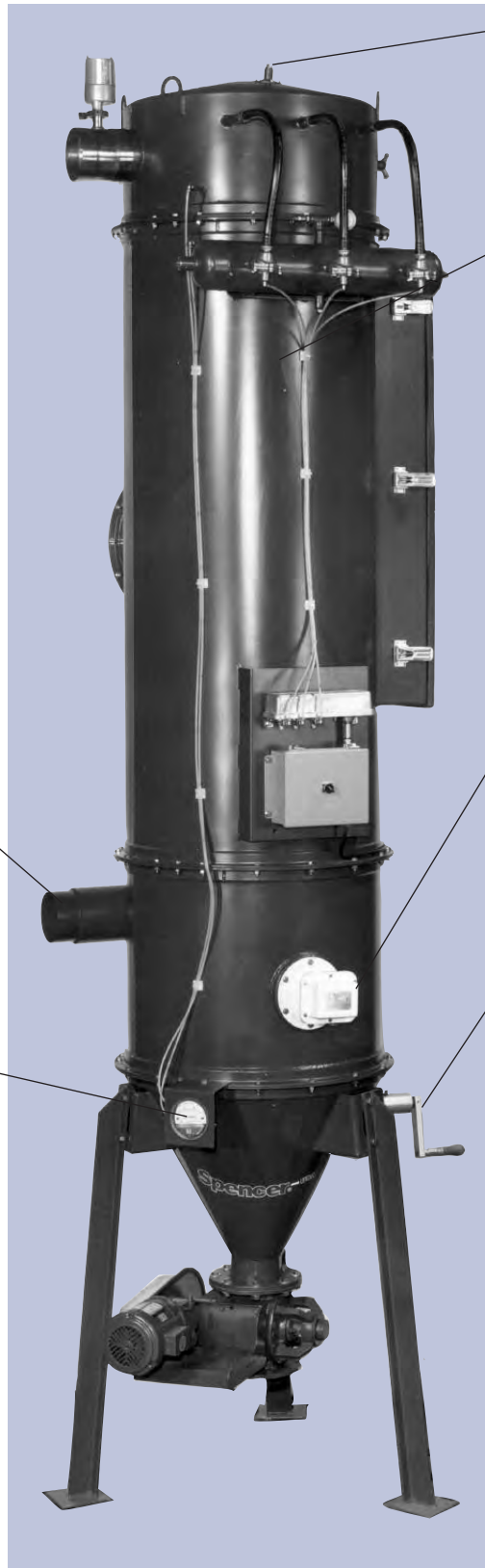

Sprinkler Head Connection

Removable cover assembly for introduction of water or chemicals to extinguish fire within separator.

Filter Bag Media Options

Filter bags of cotton sateen, cotton twill, polyester, nylon, polypropylene and Nomex® may be specified. For other possibilities, consult Spencer.

Throttling Valves

Various types of air gates and blast gates are available for airflow control and system balancing.

High Level Indicator

Various means for indicating when collected material reaches a predetermined depth; may be wired to control panel to sound alarm, activate warning light, etc.

Manual Debrider

Hand-operated device for loosening compacted materials in hopper to facilitate discharge.

Support Frame

Custom frame to support one or more separators; can be fitted with ladders and platforms for worker convenience.

HEPA Filter

Filter assembly with steel plenum and tube system connections, usually installed between vacuum producer and separator for filtration of 99.9% at 0.3 microns.

Special Fittings

Special ports, sight windows, flanged covers and connections to accommodate additional devices.

Spencer Self-Contained Systems



Series V

Industravac® mobile units (Series A, B & V)

Wheeled units which can be moved around for heavy-duty factory housekeeping, removing conveyor spills, cleaning grain elevators, vacuuming bus fleets, etc.



FastVac® one or two operator vacuum unit

Compact, heavy-duty vacuum system ideal for general cleaning applications serving one or two operators using 15' x 1-1/2" flexible hoses. The system features a Vortex regenerative vacuum producer, two-stage separator, cartridge filter and quick-release dirt can, all interconnected and mounted on a steel floor stand. Mobile and stationary units available.



Sump-Vac® mobile sump cleanout unit

Highly maneuverable, self-contained unit for cleaning machine tool coolant sumps. SumpVac vacuums liquid, chips and slurry from sumps at 14 GPM. Chips are strained out, remaining liquid accumulates in a holding tank until emptied by gravity flow or pressure. Standard tank capacities of 55 and 125 gallons.

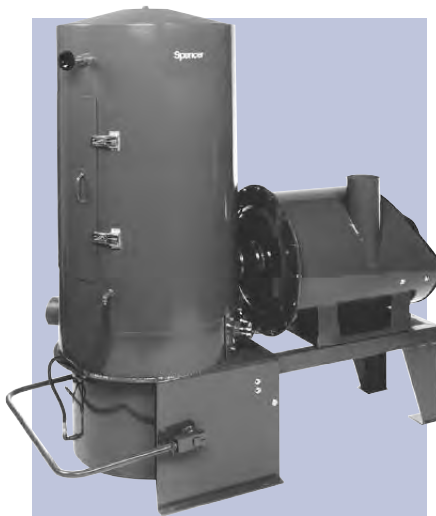

Series B

Industravac® stationary units for central vacuum systems (Series A, B, C, D & V)

Integrated Spencer system with multistage centrifugal vacuum producer and tubular bag separator with dirt can, mounted on a steel frame. Can serve a central system with one to 15 operators, or be assigned to machine-side scrap removal, high-velocity dust collection, etc.



Series D

Here's How to Start

System design consideration to discuss with your Spencer Representative.

Each Spencer central vacuum system is unique, tailored for your specific facility. To ensure that your system is planned and sized correctly, with all the service features you want, here are some of the factors to consider. By looking at these issues in advance, you can help your Spencer representative develop the right information to design a highly efficient system.

Number of operators.

How many people will be using the system? Especially, what is the maximum number of simultaneous operators? What is your work shift schedule?

Hose size.

What hose length and diameter are practical for your people and your facility? (Standard hoses are up to 50' long, 1-1/2" or 2" diameter.)

Types of applications.

Do you need cleaning only?
Bulk material handling?
Recyclable material recovery?
Toxic waste removal?
Liquid handling?

Material characteristics.

Consider the nature of the material(s) to be vacuumed, including:

- Bulk weight, volume, particle size, abrasiveness and corrosiveness of each material.
- Is it wet or dry?
- Does material tend to clump?
- In dust form, is it explosive? (If so, does your insurance company have requirements concerning its handling?)
- Is it toxic to your employees? (If so, are there regulations restricting exposure?)

Facility layout.

How many stories in your building? Do you have plans for plant expansion? Can you furnish a blueprint?

Equipment location.

What is the most logical central location for the vacuum producer and separators, to minimize tubing expense and friction loss?

Tools required.

Do you need cleaning tools only, or gulpers for bulk materials, extensions for cleaning overhead surfaces, squeegees for liquids?

There are many other issues, such as your preferred method for emptying separators and the storage capacity you need in separator collectors, which your Spencer representative will cover with you during an on-site discussion.



Spencer vacuum system removes shot blast media used during submarine reconditioning. Skid-mounted turnkey package includes all plumbing, wiring, controls, access ladders and platforms; system is ready for connection to dockside electricity and compressed air.



Spencer central vacuum system in autobody shop provides a convenient "vacuum utility" for vacuum-assisted sanding. By scavenging dust right at the source, this system keeps the whole environment cleaner—benefiting both the workers and subsequent painting operations. The vacuum tubing network extends to vacuum inlets throughout the facility for general housecleaning of floors and fixtures.



Spencer Corporate Headquarters and Manufacturing Plant, Windsor, CT USA

Spencer Products and Services

Industrially rated products offering effective solutions for air and gas handling problems

- Modular central vacuum systems
- Mobile or stationary integrated vacuum units
- Dust collectors and separators
- Multistage centrifugal blowers
- Single-stage centrifugal blowers
- High speed turbo blowers
- Regenerative blowers
- Hermetic gas boosters
- Custom-engineered products with special materials for extreme temperatures and pressures

Complementary accessories with single source convenience and compatibility

- Standard and custom electrical control panels – UL, CUL Listed and CE Compliance available
- Comprehensive selection of tubing, fittings, vacuum hoses, valves and tools
- Valves, gauges, couplings, shrink sleeves, vibration isolators and other system components

FastVac®, Industravac®, Jet-Clean®, Power Mizer®, Sump-Vac®, Top Hat®, and Vortex® are registered trademarks of The Spencer Turbine Company.

Comprehensive engineering and other customer support services

- The industry's largest complement of technical specialists in air and gas handling technology
- Global parts and service organization
- Application research and testing facility

Global organization offering

- Product selection, installation and operation assistance
- Comprehensive system design services
- Follow-up services and troubleshooting

For product selection assistance, please email marketing@spencer-air.com or visit our website at www.spencerturbine.com to locate the Spencer representative in your area.

 **The Spencer Turbine Company, 600 Day Hill Road, Windsor, CT 06095 USA**

TEL 800-232-4321 ♦ 860-688-8361 ♦ FAX 860-688-0098 ♦ www.spencerturbine.com